

MULTIFUNCTIONAL TIMER

REV-302

USERS MANUAL



This manual has been developed as introduction to the design, operating principle, working procedures and settings of the multifunctional REV-302 relay.

1 DESCRIPTION AND OPERATION

The REV-302 multi-functional relay is a microprocessor-based programmable device designed to energize/de-energize one or two loads within user-set time intervals based on the circuit voltage and the external photo sensor luminance.

1.1 GENERAL

The REV-302.01 specific features:

- 2 switching contact groups of 16A rated current at 250V switching AC voltage.
- Power supply: 220V/50Hz AC or 24V DC.
- Time relay, voltage relay and photo relay combined or independent operation.
- Flexible contact switching control between the voltage relay, the photo relay and the time relay.
- 8 independent control programs and capability of swift transfer between them for each contact group.
- Capability to control both contact groups with a single program.
- 10 year calendar standalone power supply.
- Daily, weekly, monthly, and yearly time relay program.
- Independent events settings for each program.
- Planned event clock accuracy of up to 1 second.
- Programmable holiday and day off list option.
- Specific timer listing execution for days off and holidays.
- Common internal memory for 5000 independent events distributed between all programs for day/week/month/year mode depending on the mode selected.
- Option of program cyclic repeat within a specified time interval.
- Automatic summer/winter time conversion.
- Pulse time relay function (periodic, calendar independent contacts close/open).
- Function of plain contacts closure within a specified delay after energization.
- Contacts close/open based on minimum and maximum circuit voltage.
- Temporary delay for the after-energization relay start.
- Separate time delays for the voltage relay and the photo relay actions (for setting the reclosing time, etc.)
- External photo sensor.
- LCD graphical display
- Status indication for each contact group.
- PC connection USB input.
- Control via 5 keys on the front panel.
- Loading preset control programs via USB with use of supplemental software.
- Password protection option for the settings menu.
- General reset key and manual override on the front panel.

1.2 TECHNICAL BRIEF

Output contacts specification

cos φ	Max. current at ~ 250 V AC	Maximum power	Max. current at U = 24V D.C.
1,0	16 A	4000 VA	16 A
0,4	4 A	1000 VA	
Output contacts commutation lifetime:			
- mechanical life (times)			10 ⁷
- electrical life 10A, 250V AC, times, no less than			100 thousand
- electrical life 10A, 24V DC, times, no less than			30 thousand
- electrical life 4A, 250V AC, (cos φ = 0,4), times, no less than			100 thousand

1.2.1 The basic technical parameters are shown below in table 1.1.

Table 1.1

AC voltage (terminals 7-8), V	90 ÷ 420
DC voltage (terminals 7-8), V	100 ÷ 300
Rated Auxiliary DC voltage (terminals 9-10), V	8 ÷ 30
Supply circuit frequency range, Hz	50/60
Internal fuse	available
Max number of events	5000
Clock error, sec/day, sec, not more then	1
Clock standalone operation, when de-energized, years, no less than	10
Setting accuracy, sec	1
Voltage tripping threshold setting accuracy, V	1
Voltage measurement error, %, not more then	1
Illumination intensity measurement error up to 200 lx, %, not more then	10
Illumination intensity measurement error over 200 lx, %, not more then	20
Minimum time for the time relay contacts switching, sec	0.015
Minimum time for the voltage relay contacts switching, sec	0.035
Minimum time for the photo relay contacts switching, sec	0.1
Voltage lower tripping threshold setting range, U _{min} ,V	90-416, but not more then U _{max} -dU _{max}
Voltage upper tripping threshold setting range, U _{max} ,V	94-420, but no less than U _{min} +dU _{min}
Min voltage threshold hysteresis dU _{min} , V	3 ÷ 9
Max voltage threshold hysteresis dU _{max} , V	3 ÷ 9
Tripping delay for U _{min}	from 0 sec to 19 min 99 sec
De-energize tripping delay for U _{max} *	from 0 sec to 19 min 99 sec
Load re-energization delay	from 1 sec to 19 min 99 sec
Illumination level settings range, lux	0 ÷ 9999
Illumination level settings hysteresis, lux	0 ÷ 999
Action delay if illumination is lower than the threshold value	from 0 sec to 99 min 99 sec
Action delay if illumination is higher than the threshold value	from 0 sec to 99 min 99 sec
General delay after re-energization	from 0 sec to 99 min 99 sec
Load relay trip indication	available
Settings backup in case of circuit and standalone power supply failure	available
Data memory, years, no less than	10
Computer connection	USB
Photo sensor cable length, m	2
Distance between the device and the photo sensor, m, not more then	20
Event log	year / month / week / day
Allowable humidity without condensate, %	90
Protection degree:	IP20
Power consumption (under load), VA, not more then	3.0
Weight, kg, not more then	0.150
Dimensions, mm	90 x 52 x 66
Operating temperature range, °C	from -20 to +60
Storage temperature, °C	from -35 to +70
Quantity of output relays (channels)	2
Number and type of contacts per channel (changeover contacts)	1P
Mounting:	standard 35 mm DIN-rail
Mounting position:	Any
* For fastest opening it is recommended to leave the parameter at «00 min 00 sec» value.	

1.2.2 Front panel view and dimensions are shown on fig.1.1.

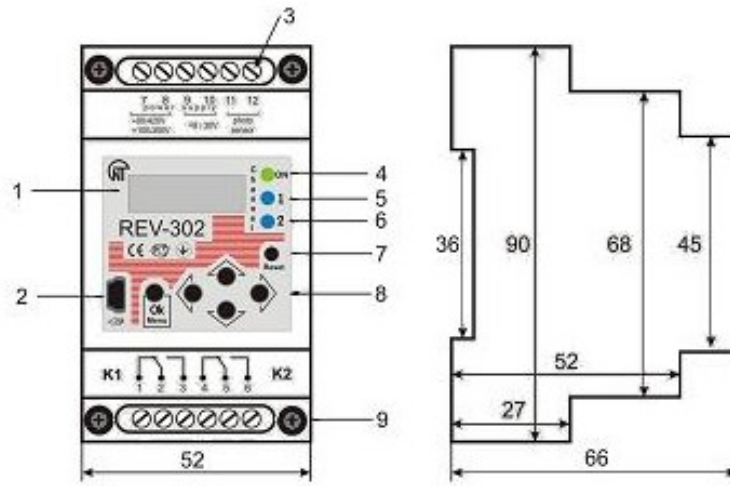

Figure 1.1 - Front panel view and dimensions

- 1 – liquid crystal display (LCD);
- 2 – USB jack for communication with PC;
- 3 – connection terminals;
- 4 – power indicator;
- 5 – channel 1 load relay energize indicator;
- 6 – channel 2 load relay energize indicator;
- 7 – reset key;
- 8 – menu navigation keys;
- 9 – mounting screws.

1.3 STRUCTURE

1.3.1 Power supply sources

REV-302 may be powered by a standard 230V/50Hz AC/DC circuit (terminals 7-8) or by a 24V DC source (terminals 9-10). Only one power source can be connected at a time.

In order to provide for the standalone clock operation in case of power voltage loss and to backup the programmed settings a 3V CR2032 lithium battery is utilized. The battery has 10 year life period.

If after an external power failure the time setting drops, the battery has to be replaced. To replace a dead battery:

- make sure that REV-302 is disconnected from the AC power supply and the DC power supply (terminals 7-10, fig. 1.1);
- unscrew the mounting screws 9;
- remove the upper cover;
- remove the old battery;
- install a new CR2032, 3V battery into the holder block;
- re-install the upper cover and the screw position 9 screws back on;
- power the device via AC or DC power supply;
- set the correct time via settings menu.

ATTENTION! The user may replace the clock battery on his/her own only in devices with expired warranty period. Otherwise, damaging the seal will cancel the manufacturer’s warranty.

1.3.2 Photo sensor

The photo sensor (figure 1.2) supplied in the REV-302 package consists of panel holder, photo receiver and twin cable to be connected to terminals 11-12. If necessary, the cable length can be extended to 20 m.

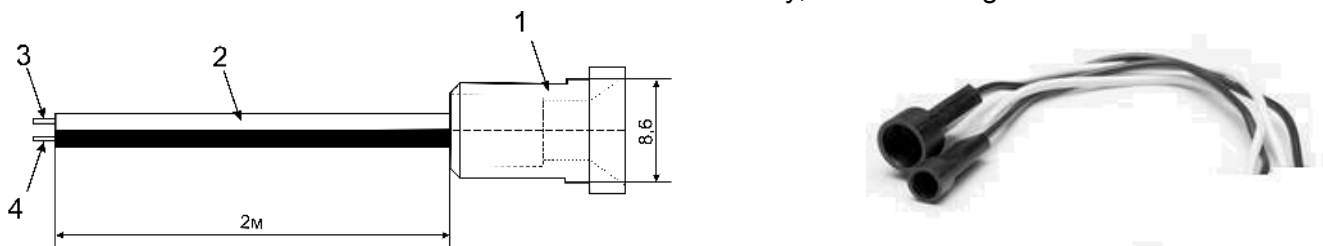

Figure 1.2 - Photo sensor diagram and exterior

- 1 – photo sensor panel holder;
- 2 – twin cable, 0,25 sq. mm. section
- 3, 4 – the photo sensor contacts (connected to terminals 11-12);

Figure 1.3 shows the sensor connection to relay terminals

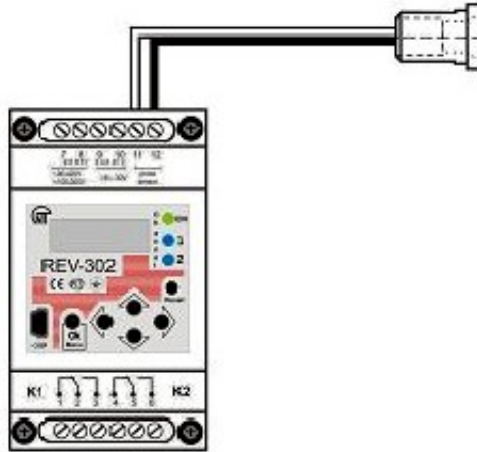

Figure 1.3 - Photo sensor connection to REV-302

2 INTENDED USE

2.1 REV-302 PREPARATION FOR USE

2.1.1 Safety

All connections must be performed on dead REV-302.

2.1.2 Connect REV-302 as shown on figure 2.1.

When using PC to write and read-off settings, connect USB cable to REV-302.

It is not necessary to observe polarity when connecting AC and DC power supply.

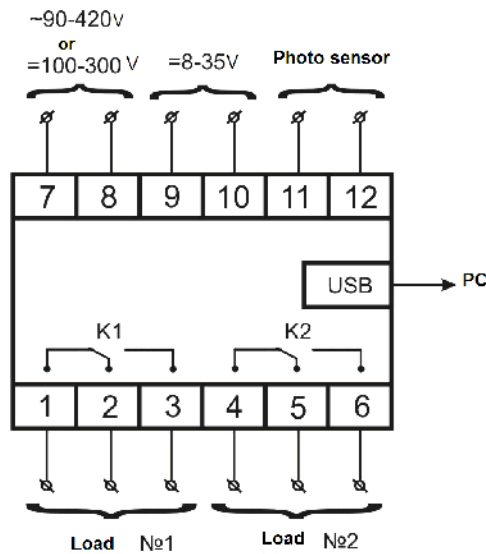

Figure 2.1 - The REV-302 wiring diagram

Switch power ON and set required operation modes according to the following section.

2.2 DISPLAY INDICATION AND SETTINGS MENU GENERAL REVIEW

2.2.1.1 Current time, voltage and illumination display window.

After external power has been supplied, the LCD displays three different windows in 6 seconds iterations:

- the current time, measured circuit voltage and photo sensor illumination level display window (fig. 2.2);
- the basic settings and current status of K1 channel display window (fig.2.3);
- the basic settings and current status of K2 channel display window.

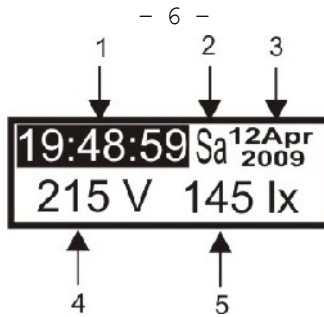

Figure 2.2 - Current time, voltage and illumination display window view

- 1 – current time;
- 2 – week day;
- 3 – date;
- 4 – K1 channel active modes;
- 5 – K2 channel active modes;
- 6 – time left till the next time relay timer activation for K1 and K2 channels accordingly;
- 7 – voltage value on terminals 7-8;
- 8 – photo sensor illumination intensity.

To swiftly toggle display windows use «▲» or «▼» keys. After one of the keys has been shortly pressed, the newly output window will be displayed for an unlimited period of time.

To resume the cyclic change of the information windows, press the «▼» key and hold it within 1 sec.

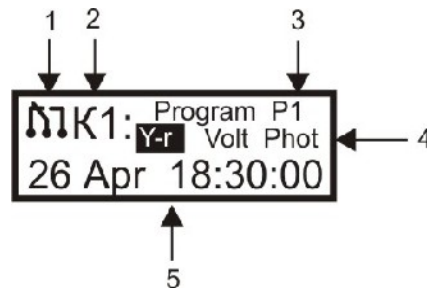

Figure 2.3 - One of the channels status window

- 1 – the corresponding channel current contacts position;
- 2 – the displayed channel;
- 3 – the channel control program (selected in the settings menu);
- 4 – active relay types for the channel (the relay which controls the contacts position at given moment);
- 5 – information about the current contacts position or about the upcoming event.

The upper half of the information window, besides the graphical view of the contacts position and the controlling program number, also displays of the active relays types. For the time relay, more detailed information is supplied in a reduced format, where:

- «Y-r» – yearly timer;
- «M-h» – monthly timer;
- «W-k» – weekly timer;
- «Day» – daily timer;
- «Pls» – pulse time relay;
- «Smp» – simple timer.

If a timer is off, a dash line «----» is displayed in its position. For instance, Fig. 2.4. shows an example of a display window for channel K1 controlled by P5 program with settings where the weekly time relay and voltage relay are switched on, but the photo relay is off:

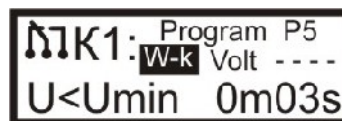

Figure 2.4

The relay currently controlling the channel's contacts is highlighted. Thus, on Fig. 2.3, it is the yearly timer, and on Fig. 2.4 – the weekly timer.

The bottom half of the display gives information either about the current status of the active relay, or about the upcoming event which will lead to the contacts commutation in accordance with the relay priority. The voltage relay has the highest priority; the time relay has the lowest priority. For the pulse timer and the simple

timer relay, the time remaining till the event is indicated, for other types of time relays, the day and time of the next upcoming event occurrence are indicated (fig 2.3). If the photo sensor has detected the illumination intensity increase above the threshold level (and the voltage relay is either off or the circuit voltage is within set limits), then the display, accordingly, shows «L<Lthr» or «L>Lthr» with indication of the time left till the commutation moment. Similarly, if the if the voltage relay is on and the circuit voltage passes the threshold values of U_{min} or U_{max} , the display shows «U < U_{min} », «Unorm» or «U > U_{max} » with indication of the time left till the contacts open (fig. 2.4), if the voltage is not within normal limits, or till the control transfer to other type relays if the voltage has returned to within set limits.

2.2.2 Settings menu

To enter settings menu, press «Menu/OK» key. If the menu is password protected, the display screen will look as shown on figure 2.5.



Figure 2.5 - Password prompt

Use «◀» and «▶» keys to select cursor position, and the «▲» and «▼» keys – to enter numbers. To confirm password press «Menu/OK».

The first settings menu looks as follows:



Figure 2.6 - Settings menu

- 1 – title of the root item in the menu;
- 2 – one of the menu items;
- 3 – menu item number within current group;
- 4 – total number of items within current group;

Use «▲» and «▼» keys to toggle the menu.

To select the current menu item, press «▶» key.

To return to the previous menu item, press «◀» key.

To exit the menu, press «◀» key several times in turn.

Structure of the principal menu elements in a tree view is presented in Appendix A. The upper menu level contains the following items:

- **K1 mode** – allows selecting the controlling program number for K1 channel.
- **K2 mode** – the same for K2 channel.
- **Programs options** – the menu branch for setting the control program options, each containing **Time relay**, **Voltage relay**, **Photo relay** items, that are covered in detail in the following chapter.
- **Settings** – allows setting common delay for the device startup after the external power supply, resetting the system time and date, setting up summer time, and correcting changes of voltage and illumination intensity.
 - **Control** – contains the following items:
 - **Clear memory** – removes all events in all control programs lists.
 - **Device reset** – resets all settings, both of the device and control programs to default values. The reset does no change the password, the time settings and the event lists.
 - **Menu password** – toggles on/off the menu entry password prompt
 - **New password** – change current menu password.
 - **Information** – displays data of the memory occupied by each control program and other service information.

2.3 USING REV-302

The REV-302 multifunctional relay has two channels: K1 and K2. Each of the K_x channels (where x is the channel number, 1 or 2) controls one electromagnetic relay with a group of switching terminals in accordance with one of the selected programs P_x (where x is the program number: 1 to 8), the programs are configured separately or loaded from PC via USB port. Configuring a number of several programs in advance allows saving time for changing channel operation modes in the future.

Each P_x program (and, accordingly, the channel K_x it controls) may be configured to operate either in three independent modes: time relay, voltage relay and photo-relay, or in four combined modes (time relay

and voltage relay, time relay and photo-relay, voltage relay and photo-relay, time relay and voltage relay and photo-relay).

2.3.1 Time relay

To set up the time relay of one of the control programs Px, perform the following menu sequence:

Menu ► Programs options ► Px program ► Time relay.

Here you can find the following menu items:

- **Select mode** – contains the following list of modes, one of which may include the time relay:
- **Switch off** – allows to completely switchg off time relay in the current control program with saving of all settings and event lists.
- **Yearly time relay** – yearly event list execution mode.
- **Monthly time relay** – monthly event list execution mode.
- **Weekly time relay** – weekly event list execution mode.
- **Daily time relay** – daily event list execution mode.
- **Pulse time relay** – the mode, where the relay contacts close and open at certain intervals after the system energizing or the settings menu exit.
- **Simple time relay** – the mode, where the relay contacts close after a certain time interval after the system energizing or the settings menu exit.
- **Time relay settings** – contains menu items that allow fine tuning the time relay:
 - **Observe days off** – the setting refers only to calendar type timers (i.e. yearly, monthly, weekly, and daily), and for days off foresees an exceptional event list in place of the currently set list for the specified timer.
 - **Observe holidays** – the setting refers only to calendar type timers, and for holidays (the holidays list is made up separately) foresees an exceptional event list in place of the currently set list for the specified timer.
 - **Cyclic rotation** – indicates whether the mode event list will be executed once within a selected time interval, or will be repeated in cycles.

Please, see an example. Figure 2.7 presents a situation when P1 is set up as a daily timer in single-action mode (i.e. the checkmark in the “Cyclic rotation” setting is not checked) with five events, each of them successively closing and opening the contacts of the controlled K2 channel. The upper graph shows the planned events in the list of daily events, the lower graph indicates the channel contacts physical status. REV-302.01 was started at the moment $t_1=4:00$, and as within the interval between t_0 and t_1 any load activating events are not present, the channel contacts will close when the time for event#1 comes ($t_2=8:00$). The last event in the day is event #5 ($t_6= 22:00$) which leaves the contacts closed until either power supply is turned off or a new program is loaded.

Figure 2.8 shows the same example, but the daily relay is in cyclic mode (i.e. the “Cyclic rotation” checkmark is checked). Unlike figure 2.7 at the moment of REV-302.01 start ($t_1=4:00$) the time relay take into account the last status the contacts had to be in before power-off. As there are no events between t_0 and t_1 , the time relay relies onto the last day event #5 ($t_6= 22:00$), according to which the contacts close. From the beginning of the next day the sequence of events is repeated.

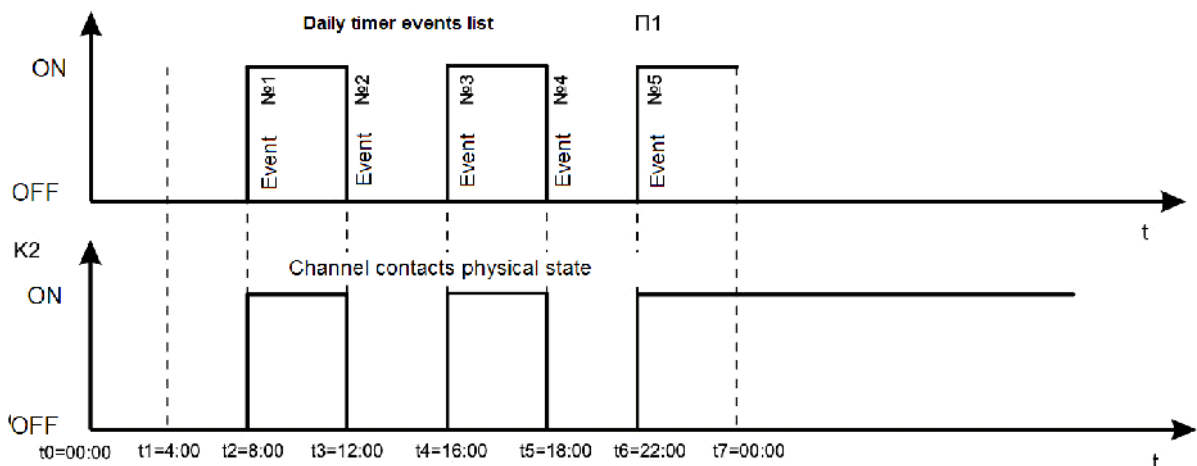

Figure 2.7 - Timer list single-action execution mode based on the daily timer example

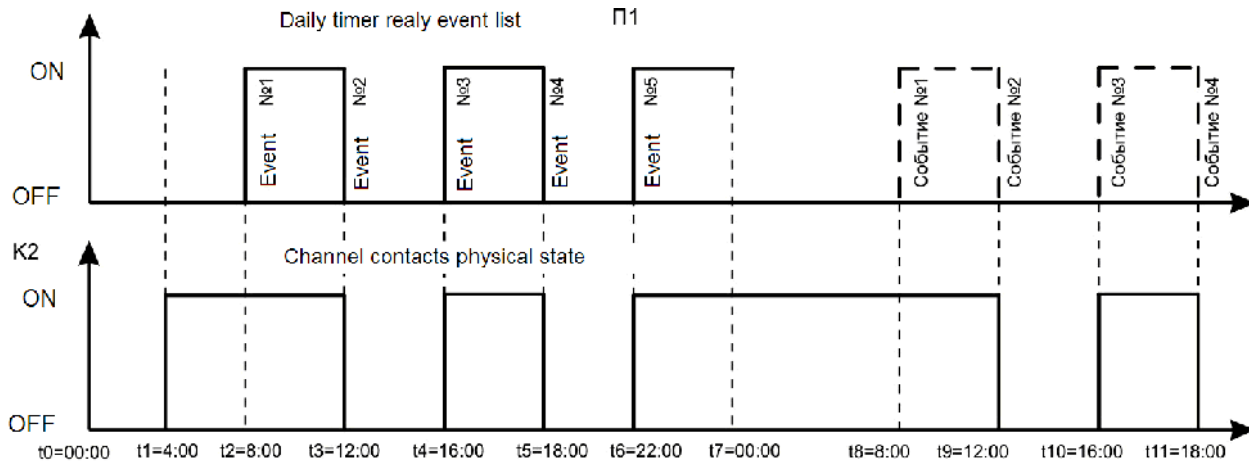

Figure 2.8 - Timer list cyclic-action execution mode based on the daily timer example

● **Exception days** – contains menu items that allow choosing days off make holidays list and exception events list, i.e. such events that will be executed on days off and holidays instead of the standard events list, if the corresponding items in the time relay settings have been selected (see previous paragraph):

● **Days off** – allows selecting days that will be considered days off.

● **Holidays** – contains the holiday list (empty by default) for the current control program. In order to add new holiday to the list press «▶» key and select “Add” item from the drop-down menu. Now the date and the month can be entered with use of the arrow keys. To exit the editor without saving changes, press «◀» key when in the leftmost item position (or just press «◀» key several times). To save the edited menu item, press «OK» key. After several list items have been created, they can be toggled with «▲» and «▼» keys. Total number of items in the list and the number of the displayed item are indicated in the upper right corner of the screen. A displayed list item can be deleted by selection of “Delete” item in the context menu. To clear all list, select “Delete ALL”.

Similar rules are valid for all editable lists of the device.

● **List of exceptional events** – contains list of events that will be executed only on days off and on holidays. For every event it is necessary to specify the time and the contacts state, to which the controlled channel contacts will be transferred on the time specified.

● **Yearly events** (list) – current program year timer event list. It is executed if the corresponding program operation mode has been selected in the mode selection menu (see above).

● **Monthly events** (list) – the monthly timer event list.

● **Weekly events** (list) – the weekly timer event list.

● **Daily events** (list) – the daily timer event list.

□ **Pulse time relay**– contains the following pulse relay settings:

● **Delay** – indicates the time that assigns the pulse relay phase shift, within which the program-controlled channel contacts will stay open after energizing or exiting the settings menu (before start of the cyclic operations execution).

● **Contacts closed** – time, for which the program-controlled channel contacts close after the preliminary delay (previous menu item) or the open contacts period (next menu item).

● **Contacts open** – time, for which the program-controlled channel contacts open after the closed contacts period (previous menu item).

□ **Simple time relay** – consists of one item only, where the delay is assigned, upon expiration of which after the system energizing or the settings menu exit, the program-controlled channel contacts will be closed.

2.3.2 Voltage relay

The voltage relay within each Px program, if it is on, monitors the voltage on terminals 7-8. If the voltage falls below the U_{min} threshold or exceeds the U_{max} threshold, then, after the set time, the contacts of the Px program controlled Kx channel will be opened regardless of the active time relay or the photo relay settings.

The control will be handed over to the time relay or the photo relay after the assigned restart time, upon return of the circuit voltage (U) to the range of

$$(U_{min} + dU_{min}) < U < (U_{max} - dU_{max}),$$

where dU_{min} and dU_{max} are the tolerance zones assigned in the settings, which allow to remove false contact commutations in case of insignificant voltage fluctuations near the U_{min} and U_{max} thresholds.

To set up the voltage relay of one of the control programs Px, perform the following menu sequence:

Menu ► Programs options ► Px program ► Voltage relay,

which contains the following menu items:

- **Mode** – allows switching the voltage relay on or off within the current control program.
- **Umin** – sets up the bottom working range threshold with the dUmin positive tolerance zone.
- **Umax** – sets up the upper working range threshold with the dUmax negative tolerance zone.
- **U < Umin** – setting the time delay before the program controlled channel contacts are opened in case of low circuit voltage.
 - **Unorm** – setting of the time delay effective before the control over the program controlled channel contacts is transferred to the time relay or the photo relay in case circuit voltage is restored to normal.
 - **U < Umin** – setting the time delay before the program controlled channel contacts are opened in case of high circuit voltage.

Figure 2.9 presents an example of the time relay and voltage relay combined operation for parameters indicated in Table 2.1.

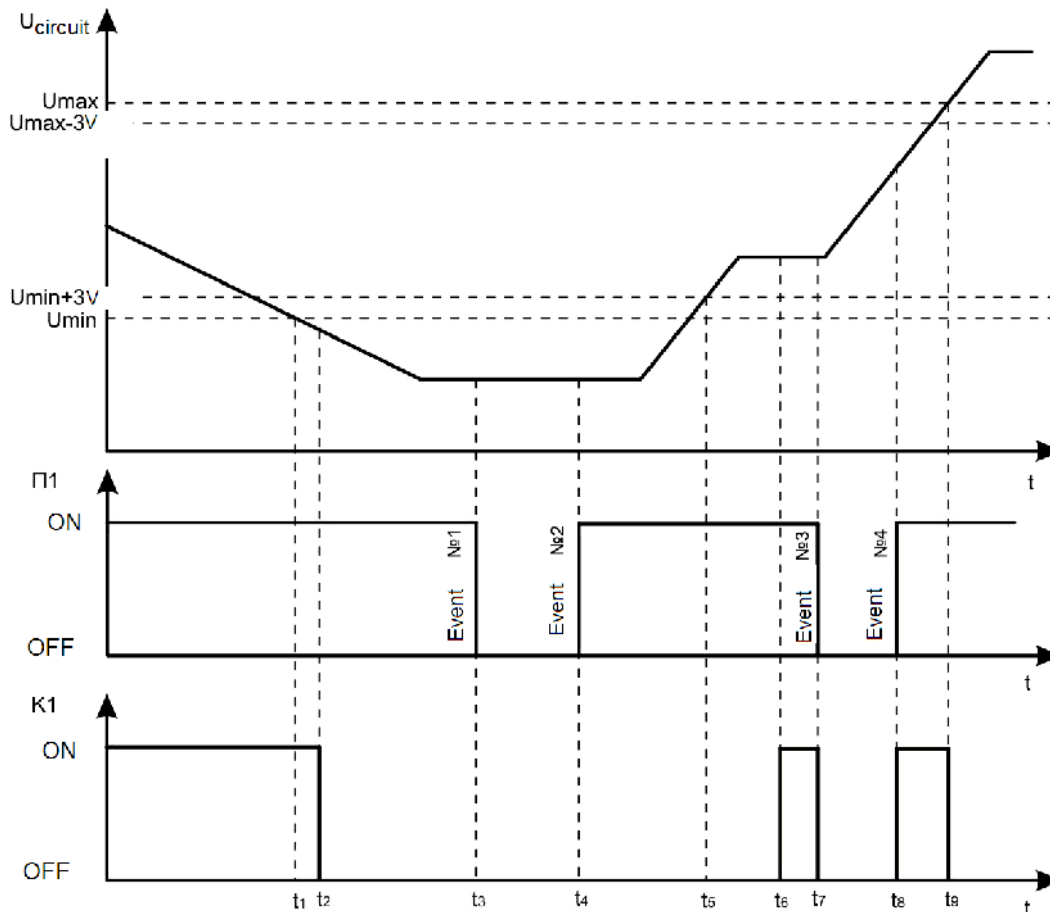

Figure 2.9 - Example of time relay and voltage relay combined operation

The upper graph $U_{circuit}(t)$ indicates the circuit voltage fluctuations. The graph $T(t)$ shows four time relay events within P1 program controlling K1 channel contacts. Thus, the timers at the moments t_3 and t_7 must open channel K1 contacts, and at t_4 and t_8 - close them. The $K1(t)$ graph shows the physical state of the K1 channel contacts. This way, at t_1 moment of time the circuit voltage crosses the U_{min} limit, and according to Table 2.2, a 12 second temporary delay starts. As within this time the circuit voltage has not exceeded the U_{min} boundary, then at the t_2 moment the channel contacts open.

Table 2.1

P1-U parameter	Value
Umin	180V
Umax	250V
dUmin	+3V
dUmax	-3V
Time delay for $U < U_{min}$	12 sec
Re-closure delay time	30 sec
Time delay for $U > U_{max}$	0 sec

While the voltage is below $U_{min}+3V$, the events at t_3 and t_4 are ignored. As soon as the voltage exceeds the $U_{min}+3V$ threshold (t_5), the 30 sec re-closure delay begins, and it ends at t_6 instance, and the control is transferred to the P1 program time relay, according to which the channel contacts are to be closed. At t_7 and t_8 moments the contacts commutation which corresponds to the time relay requirement, takes place. At t_9 moment of time the circuit voltage exceeds the U_{max} threshold, and, as according to Table 2.2 the time delay is equal to 0, the channel contacts are opened immediately.

2.3.3 Photo relay

The photo relay uses an external sensor connected to terminals 11-12 to analyze illumination intensity. Table 2.2 gives approximate illumination levels for different situations:

Table 2.2

Description	Illumination, lx
Sunlight at midday	100 000
Film shooting in a studio	10 000
Open area on an overcast day	1000
Light room near window	100
Work desk for precise operations	400–500
Cinema screen	85–120
Required for writing	30–50
Full moon	0.2
Night sky on a moonless night	0.0003

Table 2.3 gives accepted illumination standards:

Table 2.3

Room type	Illumination level (lx) according to standards International (MKO)
General purpose offices with use of computers	500
Large floor offices with free layout	750
Offices with drawing operations	1000
Conference halls	300
Stairs, escalators	150
Corridors, lobbies	100
Archives	200
Storages	100

To set up the photo relay of one of the Px control programs, perform the following menu sequence:

Menu ► Programs options ► Px program ► Photo relay,

which contains the following menu items:

- **Mode** – allows switching the photo relay on or off within the current control program.
- **Illumination threshold** – the level of illumination (lux), above or below which the contacts must be switched;
- **Hysteresis** (default +5 lx) – eliminates repetitive channel contacts commutations in case of illumination fluctuation about the set threshold;
- **L < Lthr** – setting temporary delay before executing a low illumination triggered event.
- **L > Lthr** – setting temporary delay before executing a high illumination triggered event.
- **L < Lthr Contacts** – includes a list to pick up a type of action executed on contacts upon a low illumination event:
 - **only OFF** - while the above illumination condition is active, the contacts will be open.
 - **only ON** - while the above illumination condition is active, the contacts will be closed.
 - **Correspond to the time relay** – while the above illumination condition is active, the contacts will be controlled by the time relay. If the time relay is not activated (off), the contacts will be off as well.
 - **OFF till event** – after the above illumination event activation the contacts will be opened once, after which the next time relay event may change their position.
 - **ON till event** – after the above illumination event activation the contacts will be closed once, after which the next time relay event may change their position.

