

## **TIME DELAY RELAY REV-120**

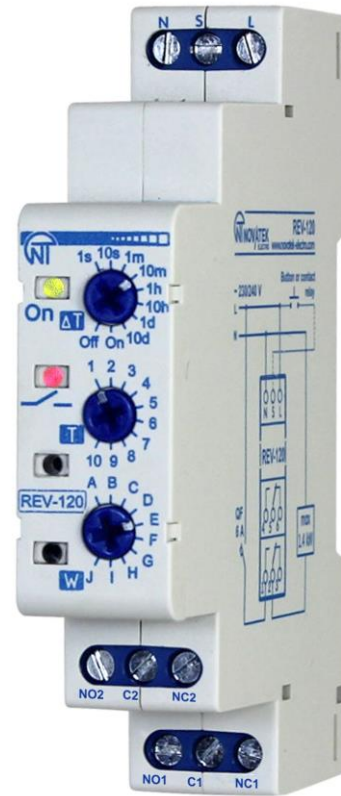

## **OPERATING MANUAL**

*The quality management system of development and production complies with the requirements of ISO 9001:2015*

**Dear Customer,**

Company thanks you for purchasing our products.  
You will be able to use properly the product after carefully studying the Operating Manual.  
Keep the Manual throughout the service life of the product.

**ATTENTION! ALL REQUIREMENTS OF THIS OPERATION MANUAL ARE COMPULSORY TO BE MET!**



**WARNING! – PRODUCT TERMINALS AND INTERNAL COMPONENTS ARE UNDER POTENTIALLY LETHAL VOLTAGE.**

**TO ENSURE THE PRODUCT SAFE OPERATION IT IS STRICTLY FORBIDDEN THE FOLLOWING:**

**– TO CARRY OUT MOUNTING WORKS AND MAINTENANCE WITHOUT DISCONNECTING THE PRODUCT FROM THE MAINS;**

**– TO OPEN AND REPAIR THE PRODUCT INDEPENDENTLY;**

**– TO OPERATE THE PRODUCT WITH MECHANICAL DAMAGES OF THE CASE.**

**IT IS NOT ALLOWED WATER PENETRATION ON TERMINALS AND INTERNAL ELEMENTS OF THE PRODUCT.**

**During operation and maintenance the regulatory document requirements must be met, namely:**

**Regulations for Operation of Consumer Electrical Installations;**

**Safety Rules for Operation of Consumer Electrical Installations;**

**Occupational Safety in Operation of Electrical Installations;**

**Installation, adjustment and maintenance of the product must be performed by qualified personnel having studied this Operation Manual.**

**The product is safe for use under keeping of the operating rules.**

This Operation Manual is intended to familiarize you with arrangement, the requirements for safety, operation and maintenance procedures of the time delay relay REV-120 (hereinafter referred to as the "product", "REV-120").

The product meets the requirements of the following:

- Low-voltage switchgear; Part 1; General rules (IEC 60947-1);
- Low-voltage circuit breaker and controller; Part 6-2; multifunctional equipment; Control and safety switching equipment (IEC 60947-6-2);
- Electromagnetic compatibility; Industrial, scientific and medical RF equipment; electromagnetic interference characteristics; standards and measuring procedure (CISPR 11);
- Electromagnetic compatibility; Part 4-2; Testing and measurement techniques; Electrostatic discharge immunity test (IEC 61000-4-2).

Harmful substances in amounts exceeding maximum permissible concentrations are not available.

**Terms and abbreviations:**

- It periodically flashes – the indicator short-time enabling.
- It periodically is off – the indicator short-time disabling.

**1. APPLICATION**

**1.1. Product application**

The time delay relay REV-120 is the microprocessor-based device intended for on/off switching the load in user-defined time intervals.

REV-120 can be operated by ten operation modes:

- on-delay;
- time delay when energizing;
- periodic with on-delay;
- periodic with time delay when energizing;
- off-delay (when control contact opening);
- pulse I (when control contact closing);
- pulse II (when control contact opening);
- on/off delay (according to control contact);
- pitch of the load relay (during each control contact closing);
- pulse generator of 0.5 s.

**1.2. Software revision history**

19.05.2016 v2 Primary version of the program

**1.3. Controls, overall and mounting dimensions of REV-120**

Controls, overall and mounting dimensions are shown in Fig.1.

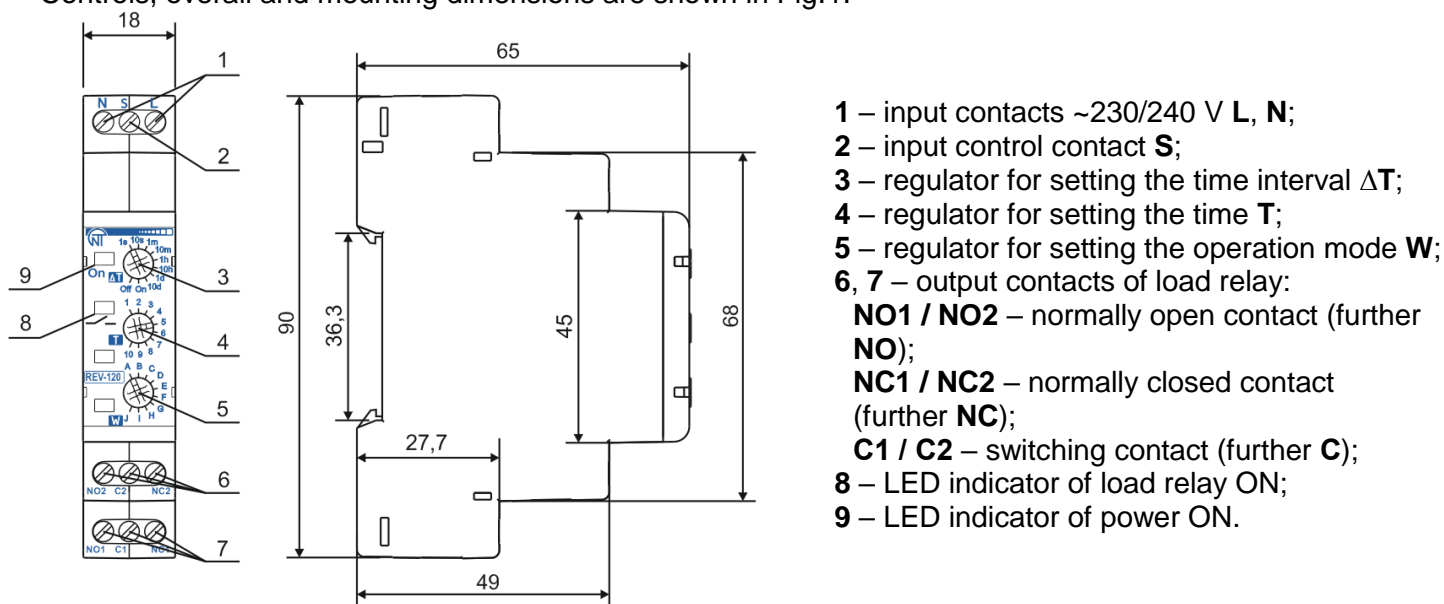

**Fig.1 – Controls, overall and mounting dimensions of REV-120**

### 1.4. Operation conditions

The product is designed for operation in the following conditions:

- Ambient temperature: from minus 30 to +55 °C;
- Atmospheric pressure: from 84 to 106.7kPa;
- Relative air humidity (at temperature of +25 °C): 30 ... 80%.

### ATTENTION! The product is not intended for operation in the following conditions:

- Significant vibration and shocks;
- High humidity;
- Aggressive environment with content in the air of acids, alkalis, etc., as well as severe contaminations (grease, oil, dust, etc.).

## 2. SPECIFICATIONS

Basic specifications of REV-120 are given in Table 1.

Specifications of the load relay contacts are given in Table 2.

**Table 1 – Basic Specifications**

Description	Value
Operating supply voltage, V	230/240 V
Frequency of supply mains, Hz	45 – 62
Voltage at which service capability is maintained, V	130-300
Permissible harmonic configuration (unsinusoidality) of power supply voltage	EN 50160
Readiness time when energizing, s, no more than	0.4
Accuracy of time delay, %, no less than	0.5
Accuracy of time setting (accuracy of scale), %, no less than	2.5
Number of operation modes	10
Adjustment range of time is divided into 10 subranges	0.1 ... 1 s 1 ... 10 s 6 s ... 1 min 1 ... 10 min 6 min ... 1 h 1 ... 10 h 0.1 ... 1 day 1 ... 10 day Continuously ON Continuously OFF
Time delay adjustment	smooth
Service of the product	Switchgear and control gear
Rated operating condition	Continuous
Type and quantity of contacts (switching)	2
Climatic design version	CN 3.1
Protection rating of case	IP40
Protection rating of terminal box	IP20
Commutation lifetime of output contacts if $\cos\varphi=1$ : - under load of 6 A, time, no less than - under load of 1 A, time, no less than	100,000 1,000,000
Power consumption (under load), W, no more than	0.5
Permissible contamination level	II
Overvoltage category	II
Electric shock protection class	II
Rated insulation voltage, V	450
Rated impulse withstand voltage, kV	2.5
Wire cross-section for connection to terminals, mm <sup>2</sup>	0.5-2
Tightening torque of terminal screws, N*m	0.4
Weight, kg, not more	0.150
Overall dimensions, H x D x L, mm	90 x 65 x 18
Product installation (mounting) is on standard 35mm DIN rail	
The product remains functional at any position in space	
Case material is self-extinguishing plastic	

**Table 2 – Specifications of output contacts of the load relay**

<b>cos φ</b>	<b>Max. current at U~250 V, A</b>	<b>Max. switching power, VA</b>	<b>Max. permissible continuous AC voltage, V</b>	<b>Max. current at U<sub>DC</sub>=28 V, A</b>
1	6	1500	250	3

### 3. INTENDED USE

#### 3.1. Preparation for operation

##### 3.1.1. Preparation for connection:

- Unpack the product (we recommend to keep the original packing for the entire warranty period of the product operation);
- Check the product for damage after transportation; in case of such damages detection, contact the supplier or manufacturer;
- Carefully study the Operation Manual (**pay special attention to the connection diagram to power the product**);
- If you have any questions regarding the installation of the product, please contact the manufacturer by telephone number indicated at the end of this Operating Manual.

##### 3.1.2. General

If the temperature of the product after transportation or storage differs from the temperature of the environment at which it is supposed to be operated, then before connecting to the mains hold the product under operating conditions within two hours (because there is possible moisture condensation on the elements of the product).

#### **ATTENTION!**

**THE PRODUCT IS NOT DESIGNED FOR LOAD COMMUTATION IN CASE OF SHORT CIRCUITS. THEREFORE, THE LOAD POWER SUPPLY CIRCUIT SHOULD BE EQUIPPED WITH THE CIRCUIT BREAKER FOR CURRENT OF 6 A MAXIMUM.**

**ATTENTION! ALL CONNECTIONS MUST BE PERFORMED WHEN THE PRODUCT IS DE-ENERGIZED.**

**Error when performing the installation works may damage the product and connected devices.**

To ensure the reliability of electrical connections you should use flexible (stranded) wires with insulation for voltage of no less than 450 V, the ends of which it is necessary to be striped of insulation for 5±0.5 mm and tightened with bootlaces. The cable cross section to connect the load depends on current (power) of the load. For example for the current of 6 A it is no less than 1.5 mm<sup>2</sup>. Wires fastening should exclude mechanical damage, twisting and abrasion of the wire insulation.

**IT IS NOT ALLOWED TO LEAVE EXPOSED PORTIONS OF WIRE PROTRUDING BEYOND THE TERMINAL BLOCK.**

For reliable contact it is necessary to perform tightening of screws of the terminal block with the force specified in Table 1.

When reducing the tightening torque, the junction point is heated, the terminal block may be melted and wire can burn. If you increase the tightening torque, it is possible to have thread failure of the terminal block screws or the compression of the connected wire.

**To improve operational properties of the product it is recommended to install the fuse or its analogue for 1 A current in power supply circuit for REV-120.**

#### 3.2. Product connection

##### 3.2.1. Adjustment of the product

Before connecting the device, you should configure it. Its setting is performed in the following order:

- The operation mode adjustment;
- The time interval adjustment;
- The time delay adjustment.

For precise positioning the regulators **ΔT** and **W** it is recommended to rotate them to the extreme left and then turning right to count the desired number of positions (fixation of position).

**Note** – *when changing the operation mode or time intervals of the product under the power supply, it is necessary to consider that the changes will take effect only after de-energizing (for at least 1 s) and re-energizing of the product.*

**ATTENTION! Not to break or rotate the regulators to excessive extent, please do not use excessive force when performing installation operations.**

**3.2.1.1. The product operation mode adjustment**

List of the REV-120 operation modes is given in table 3.

Find the desired mode of the product operation according to Table 3 and set the regulator for the operation mode setting **W** to the required position (Fig.1 it.5).

**Table 3 – Product operation modes**











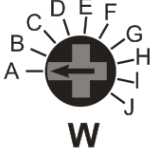
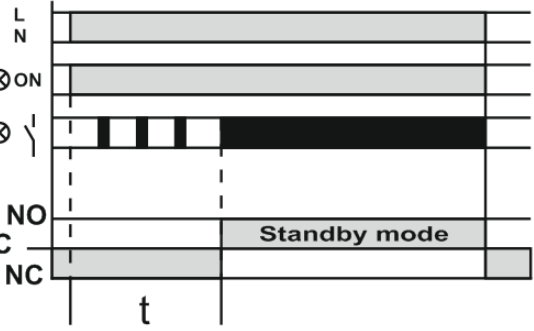

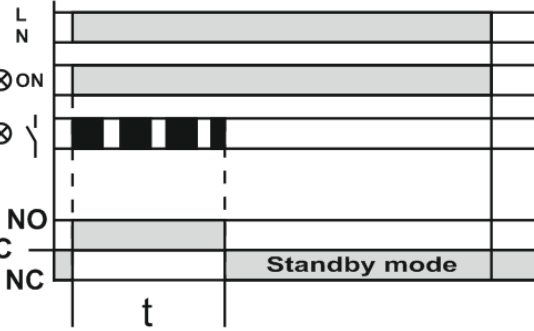

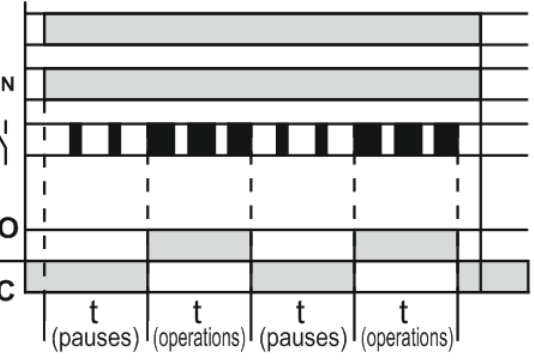
Name and W knob position	Description
<p>On-delay</p> 	<p>After energizing, the set delay time <math>t</math> (T regulator) occurs. During the delay time the indicator ON of the load relay (Fig.1 it.8) periodically flashes.</p> <p>At the end of the delay time the load relay contacts <b>NO</b> and <b>C</b> are closed, the indicator ON of the load relay is on and the product goes into standby mode until power-off.</p> 
<p>Time delay when energizing</p> 	<p>After energizing, the load relay contacts <b>NO</b> and <b>C</b> are closed, the indicator ON of the load relay (Fig.1 it.8) is on and the set delay time <math>t</math> (T regulator) occurs. During the delay time the indicator ON of the load relay periodically is off.</p> <p>At the end of the delay time the load relay contacts are opened, the indicator ON of the load relay is off and the product goes into standby mode until power-off.</p> 
<p>Periodic with on-delay</p> 	<p>After energizing, the set delay time <math>t</math> (T regulator) occurs. During the delay time the indicator ON of the load relay (Fig.1 it.8) periodically flashes.</p> <p>At the end of the delay time the load relay contacts <b>NO</b> and <b>C</b> are closed for the set time <math>t</math> and the indicator ON of the load relay is on. During the delay time the indicator ON of the load relay periodically is off.</p> <p>At the end of the delay time the load relay contacts are opened, and the product starts fulfillment of algorithm from the beginning.</p> 
<p>Periodic with time delay when energizing</p> 	<p>After energizing, the load relay contacts <b>NO</b> and <b>C</b> are closed, the indicator ON of the load relay (Fig.1 it.8) is on and the set delay time <math>t</math> (T regulator) occurs. During the delay time the indicator ON of the load relay (Fig.1 it.8) periodically is off.</p> <p>At the end of the delay time the load relay contacts <b>NO</b> and <b>C</b> are open for the set time <math>t</math> and the indicator ON of the load relay is off. During the delay time the indicator ON of the load relay periodically flashes.</p> <p>At the end of the delay time the product starts fulfillment of algorithm from the beginning.</p> 

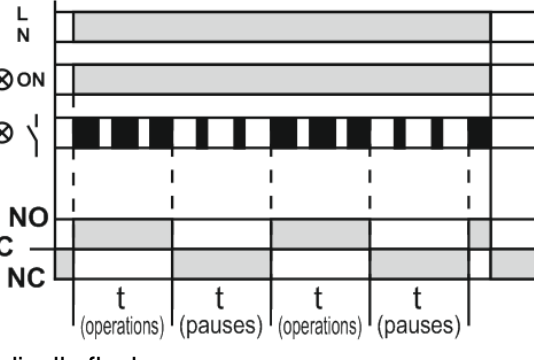
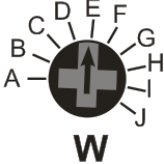
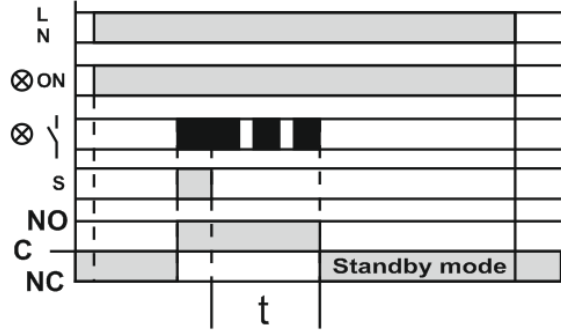
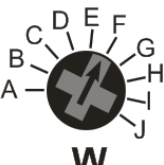
Table 3 (Continued)

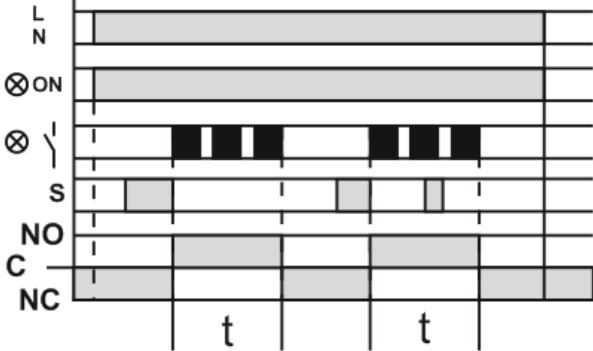
Name and W knob position	Description
<p>Off-delay</p> 	<p>After energizing, the product goes into standby mode, in this case the load relay contacts <b>NO</b> and <b>C</b> are open, and the indicator ON of the load relay (Fig.1 it.8) is off.</p> <p>When control contact <b>S</b> is closed with power supply terminal <b>L</b>, the load relay contacts are closed, the indicator ON of the load relay is on and the product goes into standby mode.</p> <p>When control contact <b>S</b> is open, the set delay time <b>t</b> (T regulator) occurs. During the delay time the indicator ON of the load relay periodically is off.</p> <p>At the end of the delay time the load relay contacts are open, the indicator ON of the load relay is off and the product goes into standby mode.</p> <p>In case of repeated closing of the control contact <b>S</b>, the algorithm is repeated.</p> 
<p>Pulse 1</p> 	<p>After energizing, the product goes into standby mode, in this case the load relay contacts <b>NO</b> and <b>C</b> are open, and the indicator ON of the load relay (Fig.1 it.8) is off.</p> <p>When control contact <b>S</b> is closed, the load relay contacts are closed, the indicator ON of the load relay is on and the set delay time <b>t</b> (T regulator) occurs. During the delay time the indicator ON of the load relay periodically is off.</p> <p>At the end of the delay time the load relay contacts are open, the indicator ON of the load relay is off and the product goes into standby mode.</p> <p>In case of opening and repeated closing of the control contact <b>S</b>, the algorithm is repeated.</p> 
<p>Pulse 2</p> 	<p>After energizing, the product goes into standby mode, in this case the load relay contacts <b>NO</b> and <b>C</b> are open, and the indicator ON of the load relay (Fig.1 it.8) is off.</p> <p>When control contact <b>S</b> is closed, the product continues being in standby mode.</p> <p>When control contact <b>S</b> is open, the load relay contacts are open, the indicator ON of the load relay is on and the set delay time <b>t</b> (T regulator) occurs. During the delay time the indicator ON of the load relay periodically is off.</p> <p>At the end of the delay time the load relay contacts are open, the indicator ON of the load relay is off and the product goes into standby mode.</p> <p>In case of closing the control contact <b>S</b>, the algorithm is repeated.</p> 

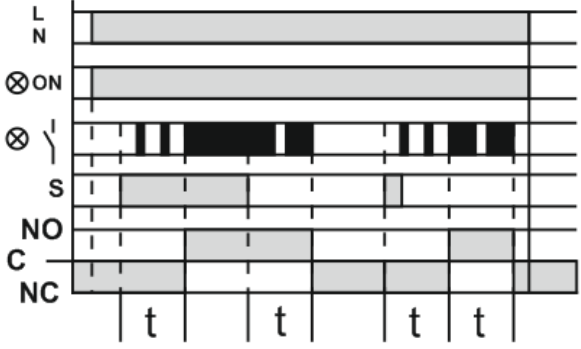
**Table 3** (Continued)

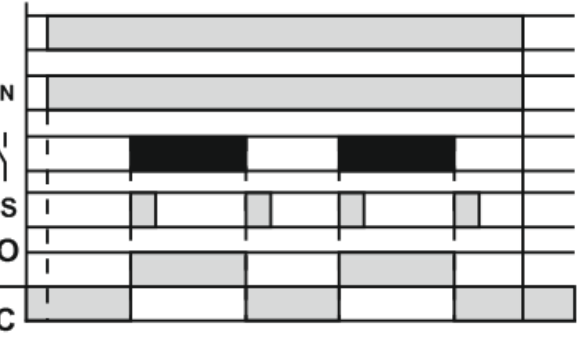
Name and W knob position	Description
<p>On/off delay</p> 	<p>After energizing, the product goes into standby mode, in this case the load relay contacts <b>NO</b> and <b>C</b> are open, and the indicator ON of the load relay (Fig.1 it.8) is off.</p> <p>When control contact <b>S</b> is closed, the set delay time <b>t</b> (<b>T</b> regulator) occurs. During the delay time the indicator ON of the load relay periodically flashes.</p> <p>At the end of the delay time the load relay contacts are closed, the indicator ON of the load relay is on and the product goes into standby mode.</p> <p>When control contact <b>S</b> is open, the set delay time <b>t</b> (<b>T</b> regulator) occurs. During the delay time the indicator ON of the load relay periodically is off.</p> <p>At the end of the delay time the load relay contacts are open, the indicator ON of the load relay is off and the product goes into standby mode.</p> <p>In case of repeated closing of the control contact <b>S</b>, the algorithm is repeated.</p> 
<p>Pitch of the load relay</p> 	<p>After energizing, the product goes into standby mode, in this case the load relay contacts <b>NO</b> and <b>C</b> are open, and the indicator ON of the load relay (Fig.1 it.8) is off.</p> <p>When control contact <b>S</b> is closed, the load relay contacts and the indicator ON of the load relay change its state to the opposite, and the product switches to standby mode.</p> <p>When control contact <b>S</b> is open, the product continues being in standby mode.</p> <p>In case of repeated closing of the control contact <b>S</b>, the algorithm is repeated.</p> 
<p>Pulse generator of 0.5 s</p> 	<p>After energizing, the set delay time <b>t</b> (<b>T</b> regulator) occurs. During the delay time the indicator ON of the load relay (Fig.1 it.8) periodically flashes.</p> <p>At the end of the delay time the load relay contacts <b>NO</b> and <b>C</b> are closed for 0.5 s, the indicator ON of the load relay is on for 0.5 s and the product goes into standby mode until power-off.</p> 

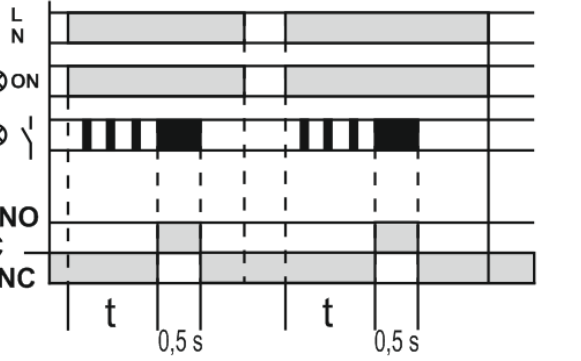
**3.2.1.2. Time interval adjustment**

List of time intervals is given in Table 4.

Find the required time interval in Table 4 and set the regulator setting for the time interval  $\Delta T$  (Fig.1 it.3) to the required position.

**Table 4 – Time intervals**

$\Delta T$ knob position	Time interval	$\Delta T$ knob position	Time interval
1 s	from 0.1 to 1 s	10 h	from 1 to 10 h
10 s	from 1 to 10 s	1 d	from 0.1 to 1 day
1 m	from 6 s to 1 min	10 d	from 1 to 10 days
10 m	from 1 to 10 min	ON	Continuously ON
1 h	from 6 min to 1 h	OFF	Continuously OFF



### 3.2.1.3. Time delay adjustment

Time delay adjustment is performed by the regulator for setting **T** time. Based on the selected time interval (it.3.2.1.2), set the required time delay.

### 3.2.2. Product connection

Connect the product in accordance with the diagram given in Fig.2.

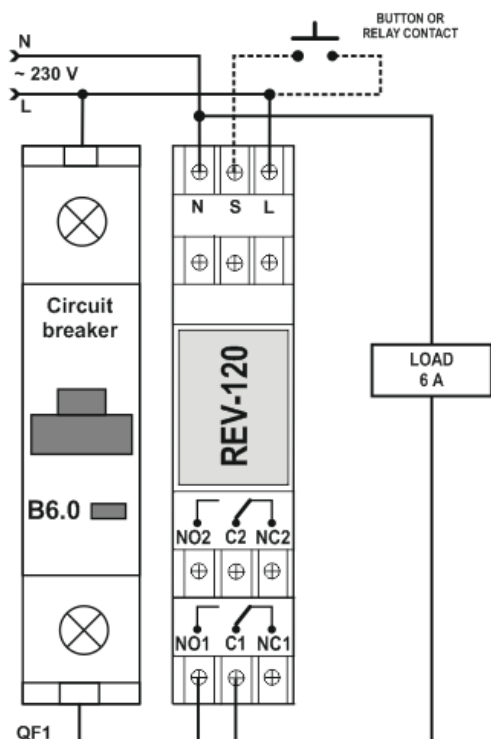

QF1 – Circuit breaker (fuse), maximum current is 6 A;

Fig.2 – Product connection diagram

### 3.3. Use of the product

After the power supply to the product the indicator **ON** (Fig.1 it.9) is on, there is small pause (no more than 400 ms) before the product begins to operate according to the selected operation mode.

The enabled load relay status corresponds to the closed condition of the contacts NO1-C1 (NO2-C2) and the open condition of the contacts NC1-C1 (NC2-C2).

The disabled load relay status corresponds to the open condition of the contacts NO1-C1 (NO2-C2) and the closed condition of the contacts NC1-C1 (NC2-C2).

Periodic flashing of LED indicator of the load relay indicates the time delay after which the load relay will on.

Periodic disabling of LED indicator of the load relay indicates the time delay after which the load relay will off.

## 4. MAINTENANCE

### 4.1. Safety precautions



**THE TERMINALS AND THE PRODUCT INTERNAL ELEMENTS CONTAINS POTENTIALLY LETHAL VOLTAGE.**

**DURING MAINTENANCE IT IS NECESSARY TO DISABLE THE PRODUCT AND CONNECTED DEVICES FROM THE MAINS.**

**4.2. Maintenance of the product must be performed by qualified service personnel.**

**4.3. Recommended frequency of maintenance is every six months.**

### 4.4. Maintenance procedure:

- 1) Check the connection reliability of the wires, if necessary, clamp with the force specified in Table 1;
- 2) Visually check the integrity of the housing, in case of detection of cracks and damages to remove the product from service and send for repair;

3) If necessary, wipe with cloth the front panel and the product housing.

**Do not use abrasives and solvents for cleaning.**

**5. SERVICE LIFE AND MANUFACTURER WARRANTY**

**5.1.** The lifetime of the product is 10 years. Upon expiration of the service life, contact the manufacturer.

**5.2.** Shelf life is 3 years.

**5.3.** Warranty period of the product operation is 5 years from the date of sale.

During the warranty period of operation (in the case of failure of the product) the manufacturer is responsible for free repair of the product.

**ATTENTION! IF THE PRODUCT HAS BEEN OPERATED IN VIOLATION OF THE REQUIREMENTS OF THIS MANUAL, THE MANUFACTURER HAS THE RIGHT TO REFUSE IN WARRANTY SERVICE.**

**5.4.** Warranty service is performed at the place of purchase or by the manufacturer of the product.

**5.5.** Post-warranty service of the product is performed by the manufacturer at current rates.

**5.6.** Before sending for repair, the product should be packed in the original or other packing excluding mechanical damage.

**You are kindly requested, in case of return of the product and transfer it to the warranty (post-warranty) service, in the field of the claims data, list the detailed reason for return.**

**6. TRANSPORTATION AND STORAGE**

The product in the original package is permitted to be transported and stored at the temperature from minus 45 to +60 °C and relative humidity of no more than 80 %.

**7. ACCEPTANCE CERTIFICATE**

REV-120 has been manufactured and accepted in accordance with the requirements of current technical documentation and classified as fit for operation.

Seal

Head of QCD

Date of manufacture

\_\_\_\_\_

\_\_\_\_\_

**8. CLAIMS DATA**

\_\_\_\_\_  
\_\_\_\_\_  
\_\_\_\_\_

*The Company is grateful to you for the information about the quality of the product and suggestions for its operation.*

For all questions, please contact the manufacturer:

NOVATEK ELECTRO INDIA PVT. LTD.

C-30, Patparganj Industrial Area, F.I.E.

Delhi – 110092, INDIA;

Tel.: +91 11 42143253

Tel./fax: +91 11 43010600

[www.novatek-electro.in](http://www.novatek-electro.in)

Date of sale \_\_\_\_\_