

TIME DELAY RELAY REV-114



OPERATING MANUAL

The quality management system of development and production production complies with the requirements of ISO 9001:2015

Dear Customer,

Company thanks you for purchasing our products.
You will be able to use properly the product after carefully studying the Operating Manual.
Keep the Manual throughout the service life of the product.



WARNING! – PRODUCT TERMINALS AND INTERNAL COMPONENTS ARE UNDER POTENTIALLY LETHAL VOLTAGE.

TO ENSURE THE PRODUCT SAFE OPERATION IT IS STRICTLY FORBIDDEN THE FOLLOWING:

– TO CARRY OUT MOUNTING WORKS AND MAINTENANCE WITHOUT DISCONNECTING THE PRODUCT FROM THE MAINS;

– TO OPEN AND REPAIR THE PRODUCT INDEPENDENTLY;

– TO OPERATE THE PRODUCT WITH MECHANICAL DAMAGES OF THE CASE.

IT IS NOT ALLOWED WATER PENETRATION ON TERMINALS AND INTERNAL ELEMENTS OF THE PRODUCT.

During operation and maintenance the regulatory document requirements must be met, namely:

Regulations for Operation of Consumer Electrical Installations;

Safety Rules for Operation of Consumer Electrical Installations;

Occupational Safety in Operation of Electrical Installations;

Installation, adjustment and maintenance of the product must be performed by qualified personnel having studied this Operation Manual.

The product is safe for use under keeping of the operating rules.

This Operation Manual is intended to familiarize you with arrangement, the requirements for safety, operation and maintenance procedures of the time delay relay REV-114 (hereinafter referred to as the "product", "REV-114").

The product meets the requirements of the following:

IEC 60947-1 (Low-voltage switchgear; Part 1. General rules);

IEC 60947-6-2 (Low-voltage circuit breaker and controller; Part 6-2; multifunctional equipment; Control and safety switching equipment);

CISPR 11 (Electromagnetic compatibility; Industrial, scientific and medical RF equipment; electromagnetic interference characteristics; standards and measuring procedure);

IEC 61000-4-2 (Electromagnetic compatibility; Part 4-2; Testing and measurement techniques; Electrostatic discharge immunity test).

Harmful substances in amounts exceeding maximum permissible concentrations are not available.

Terms and abbreviations:

- *It periodically flashes – the indicator short-time enabling.*
- *It periodically is off – the indicator short-time disabling.*

1. APPLICATION

1.1. Product application

The time delay relay REV-114 is the microprocessor-based device intended to control the load with independent time delay. It provides the certain sequence of the load operation according to the mode specified by the user.

REV-114 is equipped with control buttons and a digital display designed for adjustment and visual check of timing.

REV-114 can be operated by seventeen operation algorithms:

- on-delay;
- time delay when energizing;
- periodic with on-delay;
- periodic with time delay when energizing;
- pulse generator;
- on-delay with external start;
- off delay with external start;
- pulse I with external start;
- pulse II with external start;
- on/off delay with external start;
- pitch of the load relay (during each control contact closing);
- periodic with external start and on-delay;
- periodic with external start and time delay when energizing;
- pulse generator with external start;
- start stop;
- always ON;
- always OFF.

1.2. Controls, overall and mounting dimensions of REV-114

Controls, overall and mounting dimensions are shown in Fig.1.

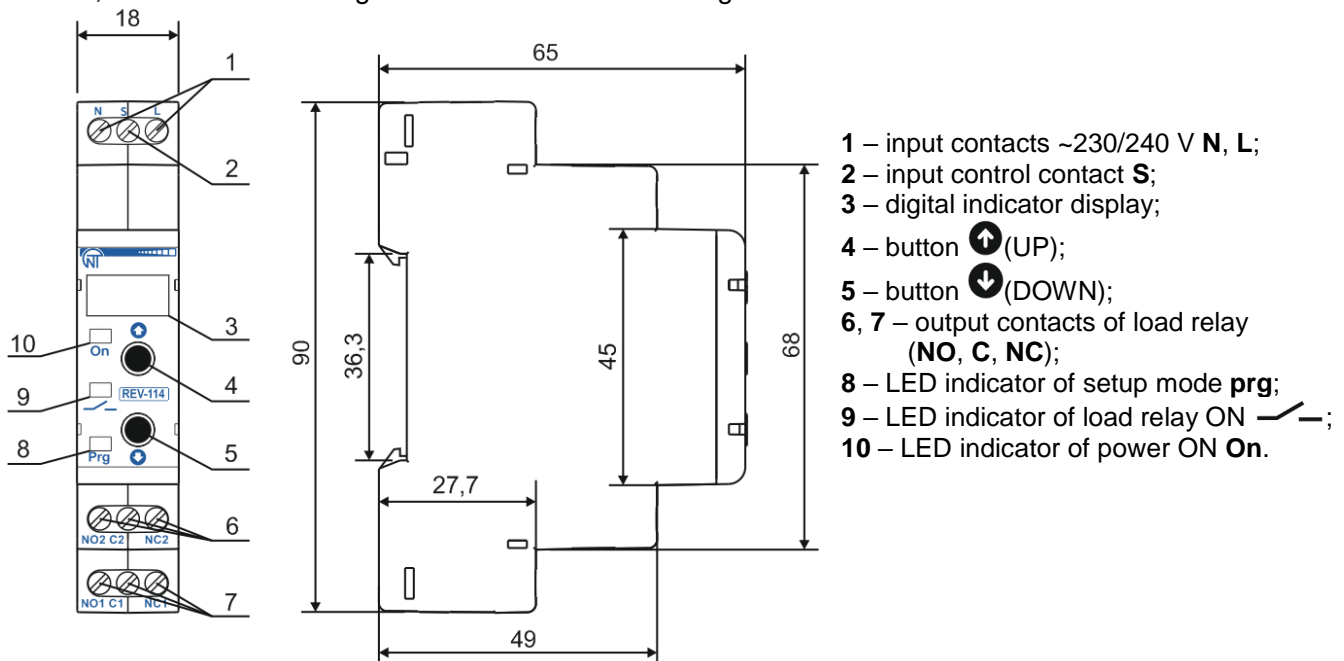

Fig.1 – Controls, overall and mounting dimensions of REV–114

1.3. Operation conditions

The product is designed for operation in the following conditions:

- Ambient temperature: from minus 30 to +55°C;
- Atmospheric pressure: from 84 to 106.7 kPa;
- Relative air humidity (at temperature of +25°C): 30 ... 80 %.

ATTENTION! The product is not intended for operation in the following conditions:

- Significant vibration and shocks;
- High humidity;
- Aggressive environment with content in the air of acids, alkalis, etc., as well as severe contaminations (grease, oil, dust, etc.).

2. SPECIFICATIONS

2.1. Basic Specifications

Basic specifications of REV–114 are given in Table 1.

Specifications of the load relay contacts are given in Table 2.

Table 1 – Basic Specifications

Description	Value
Operating supply voltage, V:	230 / 240
Frequency of supply mains, Hz	45 – 62
Voltage at which service capability is maintained, V	185 – 280
Permissible harmonic configuration (unsinusoidality) of power supply voltage	EN 50160
Readiness time when energizing, s, no more than	0.4
Accuracy of time setting holding, %, no less than	0.5
Number of operation algorithms	17
Adjustment range of time	from 0.1 s to 10 days
Timing adjustment	Buttons on the front panel
Digit display of remaining time	available
Service of the product	Switchgear and control gear
Rated operating condition	Continuous
Type and quantity of contacts (switching)	2
Climatic design version	NC 3.1
Protection rating of case	IP40
Protection rating of terminal box	IP20
Commutation lifetime of output contacts if $\cos\varphi=1$: - under load of 6 A, time, no less than - under load of 1 A, time, no less than	100 000 1 000 000
Power consumption (under load), W, no more than	0.5
Permissible contamination level	II
Overvoltage category	II
Electric shock protection class	II
Rated insulation voltage, V	450
Rated impulse withstand voltage, kV	2.5
Wire cross-section for connection to terminals, mm ²	0.5 – 2
Tightening torque of terminal screws, N*m	0.4
Weight, kg, not more	0.150
Overall dimensions, H x D x L, mm	90 x 18 x 65
Product installation (mounting) is on standard 35mm DIN rail	
The product remains functional at any position in space	
Case material is self-extinguishing plastic	

Table 2 – Specifications of output contacts of the load relay

$\cos \varphi$	Max. current at U~250 V, A	Max. switching power, VA	Max. permissible continuous AC voltage, V	Max. current at U _{DC} =28 V, A
1	6	1500	250	3

2.2. Product operation modes

The product operation modes are given in Table 3.

Table 3 – Product operation mode













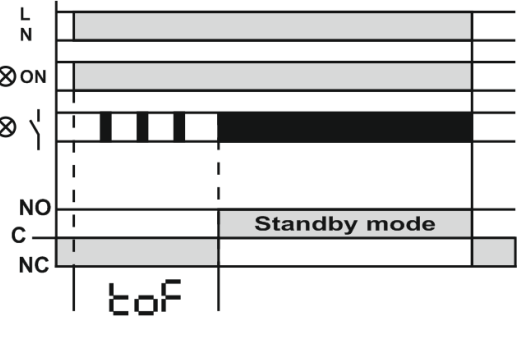



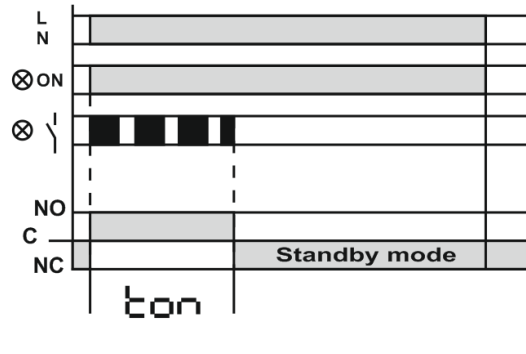

Mode number and name	Description
<p>1 On-delay</p>	<p>After energizing, the indicator ON (Fig.1 it.10) is on and the set delay time occurs toF. During the delay time the indicator  (Fig.1 it.9) periodically flashes. At the end of the delay time the load relay contacts C and NO are closed, the indicator  is on and the product goes into standby mode until power-off.</p> 
<p>2 Time delay when energizing</p>	<p>After energizing, the indicator ON (Fig.1 it.10) is on, contacts of the load relay C and NO are closed, the indicator  (Fig.1 it.9) is on and the set delay time occurs toN. During the delay time the indicator  periodically is off. At the end of the delay time the load relay contacts are open, the indicator  is off and the product goes into standby mode until power-off.</p> 
<p>3 Periodic with on-delay</p>	<p>After energizing, the indicator ON (Fig.1 it.10) is on and the set delay time occurs toF. During the delay time the indicator  (Fig.1 it.9) periodically flashes. At the end of the delay time the load relay contacts C and NO are closed for set time ton and the indicator  is on. During the delay time the indicator  periodically is off. At the end of the delay time the load relay contacts are open, and the product starts fulfillment of algorithm from the beginning.</p> 
<p>4 Periodic with time delay when energizing</p>	<p>After energizing, the indicator ON (Fig.1 it.10) is on, contacts of the load relay C and NO are closed, the indicator  (Fig.1 it.9) is on and the set delay time occurs toN. During the delay time the indicator  periodically is off. At the end of the delay time the load relay contacts are open for set time toF and the indicator  is off. During the delay time the indicator  periodically flashes. At the end of the delay time the product starts fulfillment of algorithm from the beginning.</p> 
<p>5 Pulse generator</p>	<p>After energizing, the indicator ON (Fig.1 it.10) is on and the set delay time occurs toF. During the delay time the indicator  (Fig.1 it.9) periodically flashes. At the end of the delay time the load relay contacts C and NO are closed, and the set delay time occurs ton. During the delay time the indicator  (Fig.1 it.9) periodically is off. At the end of the delay time the load relay contacts C and NO are open, the indicator  is off and the product goes into standby mode until power-off.</p> 

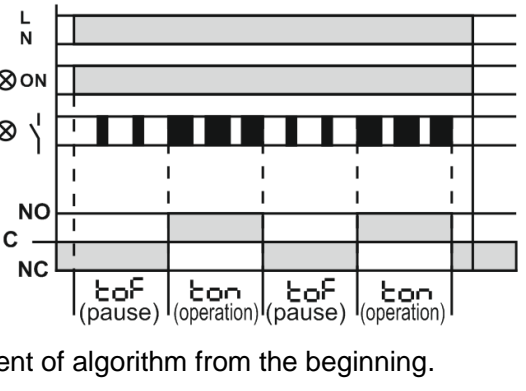
Table 3 (Continued)



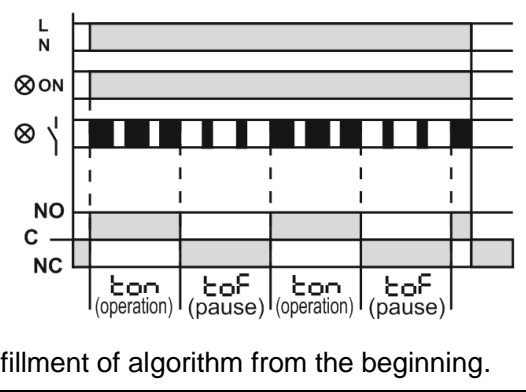



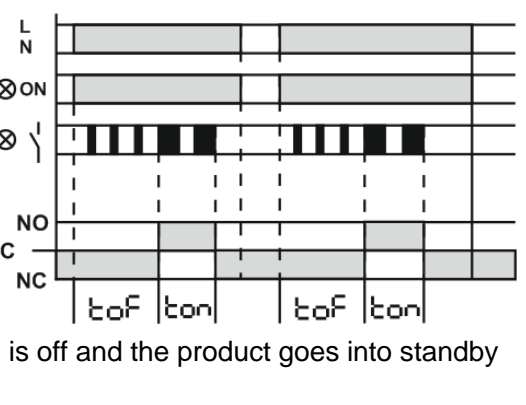







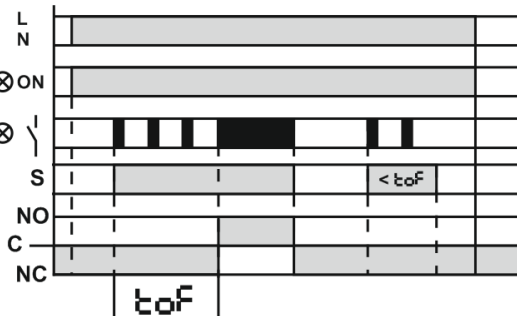

Mode number and name	Description
<p>6 On-delay with external start</p>	<p>After energizing, the indicator ON (Fig.1 it.10) is on and the product goes into standby mode, in this case the load relay contacts C and NO are open, and the indicator  (Fig.1 it.9) is off.</p> <p>When control signal S occurs, there is the set time delay t_{of}. During the delay time the indicator  (Fig.1 it.9) periodically flashes.</p> <p>At the end of the delay time the load relay contacts C and NO are closed, the indicator  is on and the product goes into standby mode.</p> <p>When there is no the control signal S, the load relay contacts C and NO are open, the indicator  is off and the product goes into standby mode</p> 
<p>7 Off delay with external start</p>	<p>After energizing, the indicator ON (Fig.1 it.10) is on and the product goes into standby mode, in this case the load relay contacts C and NO are open, and the indicator  (Fig.1 it.9) is off.</p> <p>When control signal S occurs, the load relay contacts C and NO are closed, the indicator  is on and the product goes into standby mode.</p> <p>When there is no the control signal S, there is the set time delay t_{on}. During the delay time the indicator  periodically is off. At the end of the delay time the load relay contacts C and NO are open, the indicator  is off and the product goes into standby mode.</p> <p>In case of repeated occurrence of the control signal S, the algorithm fulfillment is repeated.</p> 
<p>8 Pulse I with external start</p>	<p>After energizing, the indicator ON (Fig.1 it.10) is on and the product goes into standby mode, in this case the load relay contacts C and NO are open, and the indicator  (Fig.1 it.9) is off.</p> <p>When control signal S occurs, the load relay contacts C and NO are closed, the indicator  is on and there is the set time delay t_{on}.</p> <p>During the delay time the indicator  periodically is off.</p> <p>At the end of the delay time the load relay contacts are open, the indicator  is off and the product goes into standby mode..In case of absence and repeated occurrence of the control signal S, the algorithm fulfillment is repeated.</p> 
<p>9 Pulse II with external start</p>	<p>After energizing, the indicator ON (Fig.1 it.10) is on and the product goes into standby mode, in this case the load relay contacts C and NO are open, and the indicator  (Fig.1 it.9) is off.</p> <p>When control signal S occurs, the product remains in standby mode. When there is no the control signal S, the load relay contacts C and NO are closed, the indicator  is on and there is the set time delay t_{on}. During the delay time the indicator  periodically is off. At the end of the delay time the load relay contacts are open, the indicator  is off and the product goes into standby mode.</p> <p>When control signal S occurs, the algorithm fulfillment is repeated.</p> 

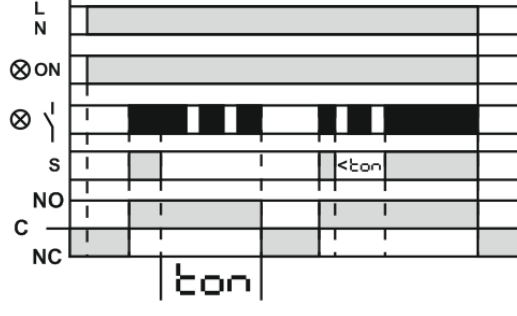
Table 3 (Continued)



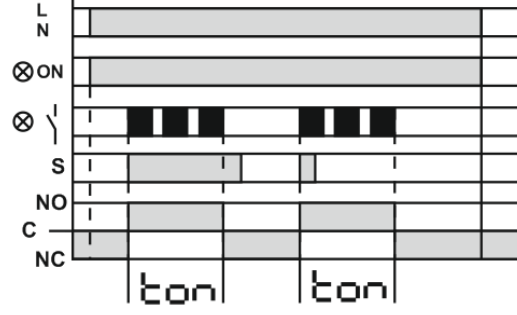



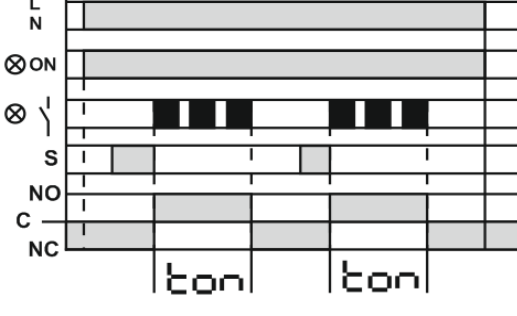















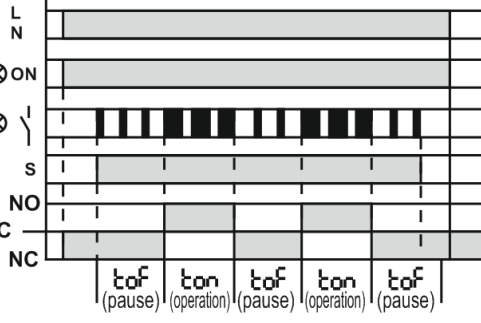



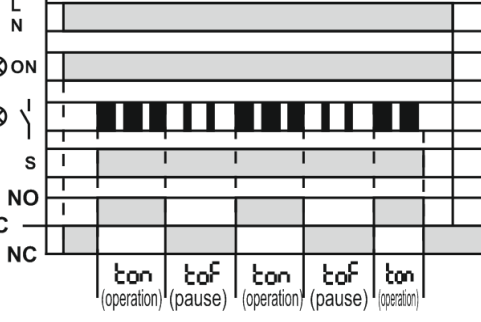

Mode number and name	Description
<p>10 On/off delay with external start</p>	<p>After energizing, the indicator ON (Fig.1 it.10) is on and the product goes into standby mode, in this case the load relay contacts C and NO are open, and the indicator  (Fig.1 it.9) is off. When control signal S occurs, there is the set time delay t_{of}. During the delay time the indicator  periodically flashes.</p> <p>At the end of the delay time the load relay contacts are closed, the indicator  is on and the product goes into standby mode. When there is no the control signal S, there is the set time delay t_{on}. During the delay time the indicator  periodically is off.</p> <p>At the end of the delay time the load relay contacts are open, the indicator  is off and the product goes into standby mode.</p> <p>In case of repeated occurrence of the control signal S, the algorithm fulfillment is repeated.</p> 
<p>11 Pitch of the load relay</p>	<p>After energizing, the indicator ON (Fig.1 it.10) is on and the product goes into standby mode, in this case the load relay contacts C and NO are open, and the indicator  (Fig.1 it.9) is off.</p> <p>When control signal S occurs, the load relay contacts and the indicator  change its state to the opposite, then the product goes into standby mode.</p> <p>When there is no the control signal S, the product continues to be in standby mode.</p> <p>In case of repeated occurrence of the control signal S, the algorithm fulfillment is repeated.</p> 
<p>12 Periodic with external start and on-delay</p>	<p>After energizing, the indicator ON (Fig.1 it.10) is on and the product goes into standby mode, in this case the load relay contacts C and NO are open, and the indicator  (Fig.1 it.9) is off.</p> <p>When control signal S occurs, there is the set time delay t_{of}. During the delay time the indicator  (Fig.1 it.9) periodically flashes.</p> <p>At the end of the delay time the load relay contacts C and NO are closed for set time t_{on} and the indicator  is on. During the delay time the indicator  periodically is off.</p> <p>At the end of the delay time the load relay contacts are open, and the product starts the algorithm fulfillment from the beginning.</p> <p>When there is no the control signal S, the algorithm fulfillment is stopped, the load relay contacts C and NO are open and the product goes into the standby mode.</p> 
<p>13 Periodic with external start and time delay when energizing</p>	<p>After energizing, the indicator ON (Fig.1 it. 10) is on and the product goes into the standby mode, in this case the load relay contacts C and NO are open, and the indicator  (Fig.1 it.9) is off.</p> <p>When control signal S, the load relay contacts C and NO are closed for set time t_{on}. During the delay time the indicator  (Fig.1 it.9) periodically is off. At the end of the delay time the load relay contacts C and NO are open for set time t_{of} and the indicator  is off. During the delay time the indicator  periodically flashes.</p> <p>At the end of the delay time the product starts the algorithm fulfillment from the beginning.</p> <p>When there is no the control signal S, the algorithm fulfillment is stopped, the load relay contacts C and NO are open and the product goes into the standby mode.</p> 

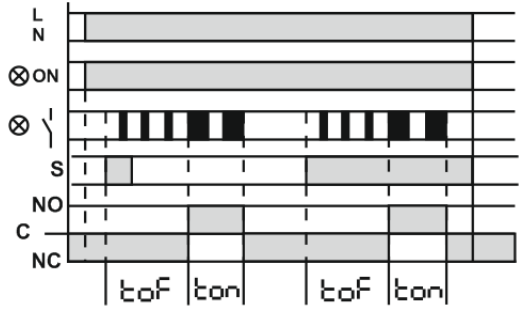
Table 3 (Continued)	
Mode number and name	Description
14 Pulse generator with external start	<p>After energizing, the indicator ON (Fig.1 it.10) is on and the product goes into the standby mode, in this case the load relay contacts C and NO are open, and the indicator  (Fig.1 it.9) is off. When control signal S occurs, there is the set time delay t_{of}. During the delay time the indicator  (Fig.1 it.9) periodically flashes. At the end of the delay time the load relay contacts C and NO are closed for the set time t_{on} and the indicator  is on. During the delay time the indicator  periodically is off. At the end of the delay time the load relay contacts are open, and the product goes into the standby mode.</p> 
15 Start-stop	<p>After energizing, the indicator ON (Fig.1 it.10) is on and the product goes into the standby mode, in this case the load relay contacts C and NO are open, and the indicator  (Fig.1 it.9) is off. When control signal S occurs, there is the set time delay t_{of}. During the delay time the indicator  (Fig.1 it.9) periodically flashes. At the end of the delay time the load relay contacts C and NO are closed, the indicator  is on. In case of repeated occurrence of the control signal S, there is the set time delay t_{on}. During the delay time the indicator  (Fig.1 it.9) periodically is off. At the end of the delay time the load relay contacts C and NO are open, the indicator  is off and the product goes into the standby mode.</p> 
16 Always ON	After energizing, the indicator ON (Fig.1 it.10) is on, the load relay contacts C and NO are closed, the indicator  is on and the product goes into the standby mode until power-off.
17 Always OFF	After energizing, the indicator ON (Fig.1 it.10) is on, the load relay contacts C and NO remain open, and the indicator  is off. The product goes into the standby mode until power-off.

3. INTENDED USE

3.1. Preparation for operation

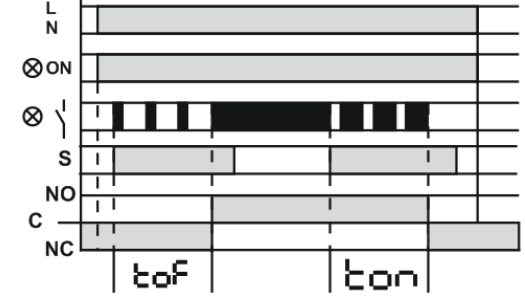
- Unpack the product (we recommend to keep the original packing for the entire warranty period of the product operation);
- Check the product for damage after transportation; in case of such damages detection, contact the supplier or manufacturer;
- Carefully study the Operation Manual (**pay special attention to the connection diagram to power the product**);
- If the temperature of the product after transportation or storage differs from the temperature of the environment at which it is supposed to be operated, then before connecting to the mains hold the product under operating conditions within two hours (because there is possible moisture condensation on the elements of the product);
- If you have any questions regarding the installation of the product, please contact the manufacturer by telephone number indicated at the end of this Operation Manual.

3.2. Product connection

Connect the product in accordance with the diagram given in Fig.2.

ATTENTION!

THE PRODUCT IS NOT DESIGNED FOR LOAD COMMUTATION IN CASE OF SHORT CIRCUITS. THEREFORE, THE LOAD POWER SUPPLY CIRCUIT SHOULD BE EQUIPPED WITH THE CIRCUIT BREAKER FOR CURRENT OF 6 A MAXIMUM.

ALL CONNECTIONS MUST BE PERFORMED WHEN THE PRODUCT IS DE-ENERGIZED.

To improve performance of the product it is recommended to install the fuse or the analogue in the power supply circuit of REV-114 for 1 A current.

To ensure the reliability of electrical connections you should use flexible (stranded) wires with insulation for voltage of no less than 450 V, the ends of which it is necessary to be striped of insulation for 5 ± 0.5 mm and tightened with bootlaces. Recommended cable cross section is no less than 1.0 mm^2 . Wires fastening should exclude mechanical damage, twisting and abrasion of the wire insulation.

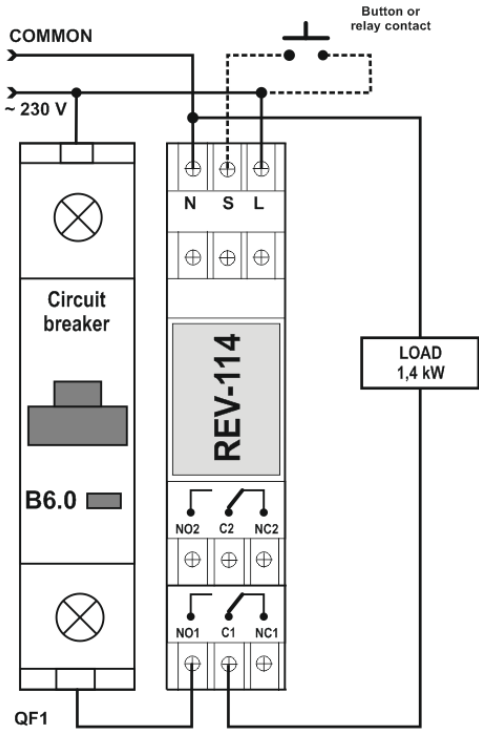

QF1 – Circuit breaker (fuse), maximum current is 6 A;

Fig.2 – Product connection diagram

IT IS NOT ALLOWED TO LEAVE EXPOSED PORTIONS OF WIRE PROTRUDING BEYOND THE TERMINAL BLOCK.

For reliable contact it is necessary to perform tightening of screws of the terminal block with the force specified in Table 1.

When reducing the tightening torque, the junction point is heated, the terminal block may be melted and wire can burn. If you increase the tightening torque, it is possible to have thread failure of the terminal block screws or the compression of the connected wire.

Error when performing the installation works may damage the product and connected devices.

3.3. Adjustment of the product

Energize the product.

On the front panel of the product, press and hold simultaneously the buttons and , after 3 s the indicator **prg** (Fig.1 it.8) is on and the display shows the first parameter of main menu (), release the buttons.

Figure 3 shows the diagram for the configuration of the product.

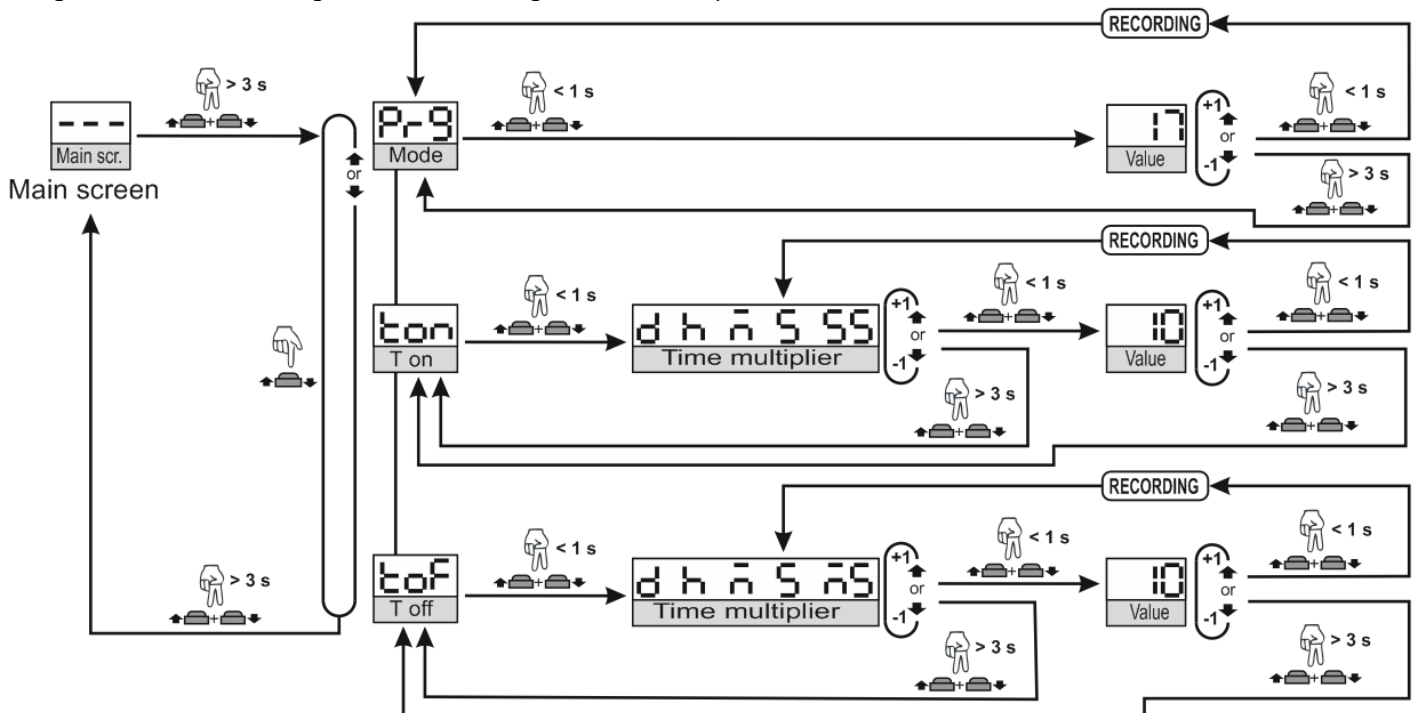

Figure 3 – Diagram for the configuration of the product

The configuration of the product is performed in the following order:

- Adjustment of operation mode (Prg);
- Adjustment of timing (ton and toF).

To exit the main menu, press and hold for more than 3 seconds the buttons $\uparrow + \downarrow$. In this case the indicator **prg** will off and the display shows the remaining time before switching on (off) the load relay.

If within 30 s neither button is pressed, the product will automatically exit from programming mode.

3.3.1. Adjustment of the product operation mode

Using the buttons \uparrow or \downarrow select the main menu item Prg (the product operation mode), confirm the selection by one time pressing of the buttons $\uparrow + \downarrow$. In this case the display will flash the current operation mode in the form of a decimal number.

Using the buttons \uparrow or \downarrow select the required operation mode (list of the operation modes for REV-114 is given in Table 3).

Press the buttons $\uparrow + \downarrow$ one time to save the selected mode and return to the main menu.

Figure 3 shows the complete programming diagram for the product.

3.3.2. Adjustment of timing

Using the buttons \uparrow or \downarrow select the main menu item ton (on-time of the load relay), confirm the selection by one time pressing of the buttons $\uparrow + \downarrow$. In this case, the display shows the submenu to select one of the units of time:

- d – days (from 0 to 10);
- h – hours (from 0 to 23);
- m – minutes (from 0 to 59);
- s – seconds (from 0 to 59);
- ms – hundreds of milliseconds (from 0 to 9).

Using the buttons \uparrow or \downarrow select the required unit of time, confirm the selection by one time pressing of the buttons

$\uparrow + \downarrow$. In this case the display will flash the current value of the selected time unit.

Using the buttons \uparrow or \downarrow set the required value.

Press the buttons $\uparrow + \downarrow$ one time to save the set value and return to the previous menu.

After setting all of the time units, press and hold the buttons $\uparrow + \downarrow$ more than 3 seconds to exit to the main menu.

Total on-time of the load relay ton consists of the sum of the values of each time unit:

$$ton = d + h + m + s + ms.$$

Adjustment of the main menu item toF (off-time of the load relay) is similar.

3.4. Use of the product

After the power supply the indicator **ON** (Fig.1 it.10) is on and the product begins to operate according to the User-selected mode (see Table 3), displaying the remaining time to turn on (off) the load relay.

Example of displaying the time:

- 10d – 10 days;
- 23h – 23 hours;
- 59m – 59 minutes;
- 59s – 59 seconds;
- 9ms – 900 milliseconds;
- - - - – time account is completed.

The time is displayed by the maximum value of time unit (not equal to zero) in the order presented above.

The enabled load relay status corresponds to the closed condition of the contacts **NO1-C1 (NO2-C2)** and the open condition of the contacts **NC1-C1 (NC2-C2)**.

The disabled load relay status corresponds to the open condition of the contacts **NO1-C1 (NO2-C2)** and the closed condition of the contacts **NC1-C1 (NC2-C2)**.

Periodic flashing of light $\text{—} \text{—} \text{—}$ indicates the time delay after which the load relay will on.

Periodic disabling of light $\text{—} \text{—} \text{—}$ indicates the time delay after which the load relay will off.

Note – when energizing the product there is a small pause (no more than 300 ms) before the product starts to operate according to the set operation mode.

4. MAINTENANCE

4.1. Safety precautions



THE TERMINALS AND THE PRODUCT INTERNAL ELEMENTS CONTAINS POTENTIALLY LETHAL VOLTAGE.

DURING MAINTENANCE IT IS NECESSARY TO DISABLE THE PRODUCT AND CONNECTED DEVICES FROM THE MAINS.

4.2. Maintenance of the product must be performed by qualified service personnel.

4.3. Recommended frequency of maintenance is **every six months**.

4.4. Maintenance procedure:

- 1) Check the connection reliability of the wires, if necessary, clamp with the force specified in Table 1;
- 2) Visually check the integrity of the housing, in case of detection of cracks and damages to remove the product from service and send for repair;
- 3) If necessary, wipe with cloth the front panel and the product housing.

Do not use abrasives and solvents for cleaning.

5. SERVICE LIFE AND MANUFACTURER WARRANTY

5.1. The lifetime of the product is 10 years. Upon expiration of the service life, contact the manufacturer.

5.2. Shelf life is 3 years.

5.3. Warranty period of the product operation is 5 years from the date of sale.

During the warranty period of operation (in the case of failure of the product) the manufacturer is responsible for free repair of the product.

ATTENTION! IF THE PRODUCT HAS BEEN OPERATED IN VIOLATION OF THE REQUIREMENTS OF THIS MANUAL, THE MANUFACTURER HAS THE RIGHT TO REFUSE IN WARRANTY SERVICE.

5.4. Warranty service is performed at the place of purchase or by the manufacturer of the product.

5.5. Post-warranty service of the product is performed by the manufacturer at current rates.

5.6. Before sending for repair, the product should be packed in the original or other packing excluding mechanical damage.

You are kindly requested, in case of return of the product and transfer it to the warranty (post-warranty) service, in the field of the claims data, list the detailed reason for return.

6. TRANSPORTATION AND STORAGE

The product in the original package is permitted to be transported and stored at the temperature from minus 45 to +60 °C and relative humidity of no more than 80 %.

7. ACCEPTANCE CERTIFICATE

REV-114 has been manufactured and accepted in accordance with the requirements of current technical documentation and classified as fit for operation.

Seal	Head of QCD	Date of manufacture
	_____	_____

8. CLAIMS DATA

The Company is grateful to you for the information about the quality of the product and suggestions for its operation.

For all questions, please contact the manufacturer:

NOVATEK ELECTRO INDIA PVT. LTD.

C-30, Patparganj Industrial Area, F.I.E.

Delhi – 110092, INDIA;

Tel.: +91 11 42143253

Tel./fax: +91 11 43010600

www.novatek-electro.in

Date of sale _____

